



RODHA KHALID COMPANY



 www.rodhakhalid.com

 +974 44310454

 +974 44415951

 +974 44438206

 +974 44435102

 PO BOX : 5767

 sales@rodhakhalid.com

ABOUT US

Rodha Khalid Company is well known and respected as one of the leading suppliers of world class plumbing products in the State of Qatar. It's a reputation earned through a total dedication to quality and customer service that's been the hallmark of the company since it was established in the year 1986. Since its inception, Rodha Khalid Co. has been part of most of the prestigious projects in Qatar and was instrumental in providing state of the art solutions in plumbing applications. We at Rodha Khalid aspire to provide the best construction products and integration services to the building and construction industry of this country.

ISO 9001:2015 Certified

To fulfill our commitment to adhere to global standards. Rodha Khalid has been ISO certified. We are further committed to achieving customer satisfaction using quality procedures which are operated to meet or exceed the requirements of ISO 9001.

Quality Assurance

Rodha Khalid Company has heavily invested in quality and prides itself in delivering highest standards of products and services throughout Qatar and the other parts of Middle East. The Company has developed its expertise since its establishment and its aim is to sustain and raise the bars of quality of deliverables to the construction industry.

Service

It is the policy of Rodha Khalid Company to provide total value for money and satisfy the customers with goods and services to the agreed requirement in accordance with the details and price. The company believes that its market expects a continually improving service. We aim to continually improve the service we provide to meet the client's requirements and to provide solutions that we can justifiably be proud of.

Why choose RKC

Rodha Khalid Company started its operations 35 years ago in the capital city of the State of Qatar, Doha and has been the most preferred supplier of building, infrastructure materials and sanitary ware in the country ever since. From the very inception in 1986, Rodha Khalid Company has been a market leader in the construction industry with satisfied customers, contractors and consultants. Over the years it has gained reputation in the market as an efficient supplier and exclusive partner for well-known international brands, conforming to the highest standards of quality and performance. Some of the international brands represented by us are Pegler Valves, Yorkshire Tubes and Fittings, Stuart Turner Pumps, Thermex and Ariston water heater etc.



HESSE



ARMAMIX

Pegler Yorkshire

PEGLER (PY)

Conex | Bänninger

DiZAYN GRUP

Wednesbury

ESPA Innovative Solutions

BAILEY PRODUCTS

Makita

PHILIPS

eral

SISTEMA

DEWALT

BLACK & DECKER



YORKSHIRE COPPER TUBE

VAREM



EUMEL

DUDLEY Thomas Dudley Ltd.

Aqua SWITCH

GULF O FLEX

GROHE

CEPEX

ARISTON

Sunex

B METERS

tenby

ritalin

ATLAS FILTRI

ERA

HARO Toilet Seats since 1912

idrospania

tucal

TAC TOP ANCHOR CERAMIC



Hotex

Doulton Water Filters

ROBSON

Prestex

STUART TURNER

Patel

GRUNDFOS

VICTORY

Aqua

eurorama

Supreme People who know plastics best

































3M Aqua-Pure

















Rafello WATER PUMPS

etto

Index

 PEGLER VALVES	01
 YORKSHIRE FITTINGS - ENDEX & SOLDERING	02
 COPPER PIPES - YORKSHIRE & MUELLER	03
 COMPRESSION FITTINGS - CONEX & RKC	04
 PPR PIPE & FITTINGS - K AQUA-DIZAYN- PVC FITTING SUPREME	05 - 07
 PRESSURE VESSEL - VAREM	08
 WATER METER - B METER	09
 TESTING PLUG - BAILEY	10
 WATER PUMPS - SISTEMA - RAFELLO - ESPA - STUART - GRUNDFOS	11 - 15
 WATER HEATER - THERMEX - ARISTON - SUNEX - RHEEM	16 - 19
 PVC FITTINGS ERA - PVC, HIGH PRESSURE, PPR, POLYTHENE, ELECTRICAL	20 - 21
 MIXERS - EURORAMA-ARMAMIX -GROHE -HESSE	22 - 25
 YELLOW HOSE - EUROFLOW	26
 CISTERN WC TANK - DUDLEY	27
 FLOAT SWITCH - AQUA SWITCH	28
 HP PRESSURE FITTINGS & VALVES - CEPEX	29
 FLEXIBLE HOSE & SHATTAF - TUCAI - IDROSPANIA	30
 TILES	31
 FLOOR DRAINS - EUMEL	32
 PPR MACHINE - ERAL	33
 WC FITTINGS & SHATTAF - MEGA	34
 SANITARY WARES - TOP ANCHOR - DOLAVIS	35 - 36
 GI FITTINGS AND PIPES	37
 MAN HOLE COVERS	38
 RUBBER INSULATION	39
 PAINTS	40 - 41
 SEAT COVERS - PATEL - HARO	42 - 43
 WATER & ELECTRIC CABINETS - QATAR	44
 ADHESIVES	45
 WATER FILTER & CANDLES - AQUAFILTER - HESSE	46 - 47
 SHOWER HEAD AND SETS - HESSE	48 - 49
 WC FITTINGS - HESSE	50 - 51

Index

 SHATTAF & SHOWER HOSE - HESSE	52
 BATHROOM ACCESSORIES - HESSE	53
 ANGLE VALVES & TAPES	54 - 55
 SOAP DISPENSER - HESSE	56
 BATHTUB & SHOWER TRAYS - HESSE	57
 SEAT COVERS - HESSE	58
 PRESSURE CONTROL, GUAGES , TEFLONE TAPES, HESSE	59
 GI THREADED RODS , CLAMPS , CP FITTINGS	60
 BRASS FITTINGS & VALVES - HESSE	61
 KITCHEN SINK - HESSE	62
 ELECTRICAL , HARDWARES & MACHINERY	63
 AQUA ECO BATH FITTINGS & ACCESSORIES	64 - 66
 MIX PRODUCTS	67
 CERTIFICATES	68 - 69

Distributor Certificate

Pegler Yorkshire Group Limited are proud to appoint Rohda khalid company Qatar as an officially approved distributor of Pegler Valves



Pegler Yorkshire Group Limited is Registered in England No. 00401407. Registered Office: Haigh Park Road, Stourton, Leeds, West Yorkshire, LS10 1RX.



Gate Valve | Ball Valve | Float Valve | NRV
Brass Spring Foot Valve | Angle Valve | Hose Bib Tap

Versatility
and
Reliability

VSH MultiPress

multi-profile press fittings
& tube, 16-63mm





ENDEX AND SOLDERING FITTINGS





Made In UK



COPPER PIPES



COMPRESSION FITTING



PPR PIPE & FITTING





Made In Turkey

DIZAYN GROUP



DIZAYN GROUP

32 YEARS

Istanbul, 13.05.2019

TO WHOM SO EVER IT MAY CONCERN

We Dizayn Teknik Boru ve Elemanları San. Tic.A.Ş. Manufacturer of PPRC, PPRH and PE Pipes fittings under the brand name of "DIZAYN GROUP" hereby certify that M/s RODHA KHALID COMPANY is one of distributors of "DIZAYN GROUP".

This is for your information.

Yours truly,

DIZAYN TEKNİK BORU VE ELEMANLARI SAN. TİC. A.Ş.
KURUM GENEL MÜDÜRÜ
M. S. KUTLU
No: 3212 40.02 41.11 Paş. 1074 1074 1074
Büyükdere Mahallesi No: 3212 40.02 41.11 Paş.
Mavi No: 3212 40.02 41.11 Paş.



Atatürk Mah. Adnan Menderes Cad.
No: 6 34522 Esenyurt, İstanbul-TÜRKİYE
T: +90 (212) 896 5741
F: +90 (212) 896 5393
www.dizayngroup.com

A TECHNOLOGY WITH NO SLOWING DOWN BY THE CURVES

30% EASIER WATER FLOW BY SPECIAL DESIGN

UNIQUE TECHNOLOGY IS ONLY WITH DIZAYN

NO MORE LEAKAGE!

FIRST IN THE WORLD

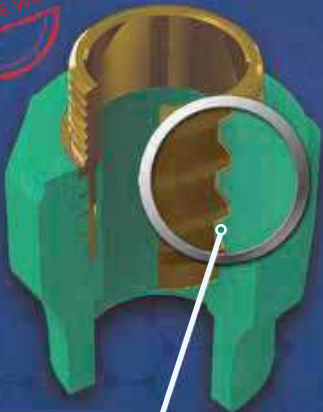

Molecular bond





IS 15801:2008
CML/ 7989319



Total Piping Solution



















Hot and Cold Water System

The most reliable plumbing system



Fittings

-  Coupler
-  Elbow 90°
-  Reducing Elbow
-  Elbow 45°
-  Female Threaded Elbow 90° with supporting device
-  Threaded Plug
-  Union
-  Reducer Female/Female
-  End Cap
-  Female Threaded Elbow 90°
-  Female Threaded Joint (FTA)
-  Male Threaded Joint (MTA)
-  M.T.A. (Plastic)
-  Union - Male Threaded (SxMT)
-  Concealed Valve
-  Screw Tap with Handwheel



AQUAVAREM

PRESSURE TANKS WITH DIAPHRAGM MEMBRANE



PRESSURE TANKS

Quality solutions for all volumes

INTERVAREM LS CE	-10 +99 °C	Codice stand.	Capacità	Pressione max	Raccordo	Dimensioni	Imballo	Qtà/pallet
		Std. Code	Capacity	Max. pressure	Connection	Dimensions	Packaging	Qty/pallet
			lt	bar	inch	mm	m ³	n.
		S2005361CS000000	5	8	1'	160x332	0,010	210
		S2008361CS000000*	8	8	1'	200x348	0,015	144
		S2012361CS000000*	12	8	1'	270x308	0,024	84
		S2019361CS000000*	19	8	1'	270x415	0,031	63
		S2020361CS000000	20	8	1'	250x500	0,038	56
		S2024361CS000000*	24	8	1'	351x358	0,045	54
		S2025361CS000000*	25	8	1'	290x472	0,041	63
		S2040361CS000000*	40	8	1'	320x595	0,066	36
		US050361CS000000	50	10	1'	379x759	0,126	15
		US060361CS000000	60	10	1'	379x825	0,131	15
		US080361CS000000	80	10	1'	450x789	0,170	15
		US100361CS000000	100	10	1'	450x910	0,200	15
		US150461CS000000	150	10	1'1/2	554x1040	0,340	8
		US200461CS000000	200	10	1'1/2	554x1250	0,407	8
		US300461CS000000	300	10	1'1/2	624x1370	0,596	6
		US500461CS000000	500	10	1'1/2	790x1460	0,900	1
		US750461CS000000*	750	10	1'1/2	786x1925	1,300	1
		USN10H61CS000000*	1000	10	2'	945x1912	1,900	1
		S3N15H61CS000000**	1500	10	2'	1150x2080	3,020	1
		USN20H61CS000000*	2000	10	2'	1280x2080	3,720	1
		S3N30H61CS000000**	3000	10	2' 1/2 F	1250x2710	4,500	1

WATER METER





Made In England



BAILEY
PRODUCTS

BAILEY" RANGE OF DRAIN TEST PLUGS

For popular sizes/Part numbers please see over



Bailey Products
Liverpool street, England, B9 4DS
Visit Web Site www.bailey-products.com

WATER PUMP



ELETTROPOMPE VOLUMETRICHE
VOLUMETRIC PUMPS



ELETTROPOMPE CENTRIFUGHE
CENTRIFUGAL PUMPS
MONOGIRANTI
SINGLE IMPELLER



TDP 300/S

ELETTROPOMPE
SOMMERSE PER DRENAGGIO
SUBMERSIBLE
DRAINAGE PUMPS



TDP 400-800/S

ELETTROPOMPE SOMMERSE INOX
PER ACQUE CARICHE
STAINLESS STEEL SUBMERSIBLE PUMPS
FOR DIRTY WATER



RAFELLO WATER PUMPS



QUALITY PUMPS SINCE 1977

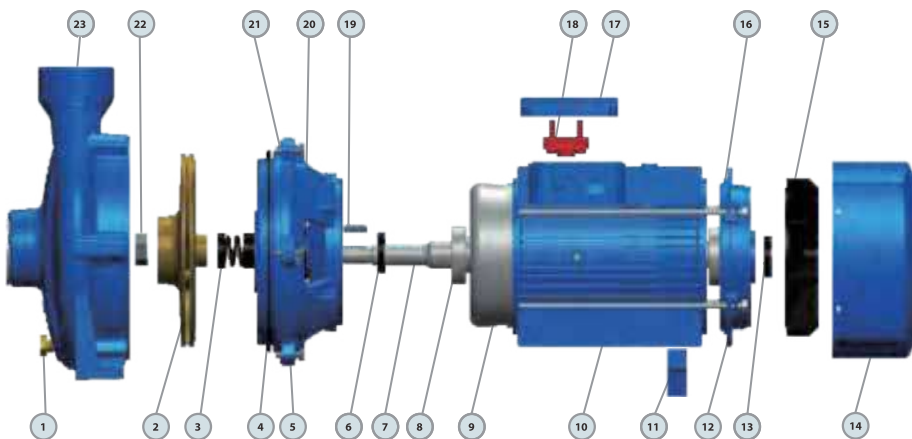

RVM16-6-0.75 RVM16-6-0.75G
RVM16-7-0.75 RVM16-7-0.75G



RTP2

No.	Description	Material
1	Release Valve	Brass
2	Impeller	Brass
3	Mechanical Seal	SiC/Carbon/SS304
4	O-ring	Rubber
5	Connection	Cast iron
6	Reinforced Seal	Rubber
7	Shaft	SS304/45# Steel
8	Bearing	Ball Bearing

No.	Description	Material
9	Wound Stator/Rotor	Silicon Steel/Copper
10	Motor Case	Aluminum
11	Support Foot	Plastic
12	Back Cover	Cast iron
13	Reinforced Seal	Rubber
14	Fan Cover	Aluminum
15	Fan	Plastic
16	Through Bolt	Steel

No.	Description	Material
17	Terminal Box	Aluminum
18	Terminal Board	Plastic
19	Impeller Key	Iron
20	Water Deflector	Rubber
21	Connection Bolt	Steel
22	Impeller Nut	Galvanized Steel
23	Pump Case	Cast iron



WATER PUMP





Made In UK

STUART TURNER

ENGINEERED TO EXCEL



POWERING WATER FOR EVERY APPLICATION





Made In UK

GRUNDFOS CM
Horizontal multi-stage pumps up to 7.5 kW

WATER PUMP GRUNDFOS

WHEN
CUSTOMISATION,
MODULARITY,
AND RELIABILITY
ARE KEY



be
think
innovate

GRUNDFOS 

WATER HEATER



WATER HEATER

TO WHOM IT MAY CONCERN

Subject: Authorization Letter

We, Ariston Thermo SpA, hereby would like to inform that M/S. **RODHA KHALID COMPANY** is one of our main authorized distributors who is working for ARISTON® electrical heating system:

Contact Details:

RODHA KHALID COMPANY
QATAR
P.O. box : 5767
Phone: +974 4 310454
Fax: +974 4 435102

Note: This certificate is subject to renewal every 6 months as per ARISTON THERMO GROUP policy, and the validity starts from the above mentioned date.

We remain at your complete disposal for any more information you may require.

Regards,

Ariston Thermo SpA Middle East Branch

Ariston Thermo SpA Middle East Branch
Dubai Airport Freezone
Building # 5EB - Office # 829
P.O.Box: 94543, Dubai - U.A.E

Ariston Thermo SpA
Viale Aristide Merloni 45 60044 Fabriano (AN) T. (+39) 0732 8011 F. (+39) 0732 602331
www.aristonthermo.com

Cap.Soc. €11.850.000,00 - Ing. Improb. Modulo C.I.L.F.ITALY 038830427

High-efficiency
electric and gas-fired water heaters.
Up to -20% energy consumption
compared to traditional water heaters.



**ADVANCED
PERFORMANCE**

**TITANSHIELD
TECHNOLOGY**



50 lr, 80 lr, 100 lr

WATER HEATER



Made In Mexico



The new degree of comfort.™

HOT WATER SOLUTIONS

Reliable & energy efficient water heaters for all applications



Water Heaters

www.rheem-mea.com

**UPVC
HIGH PRESSURE
& DRAINAGE FITTINGS**



POLYTHENE COMPRESSION



ELECTRICAL FITTINGS





MIXER TAPES

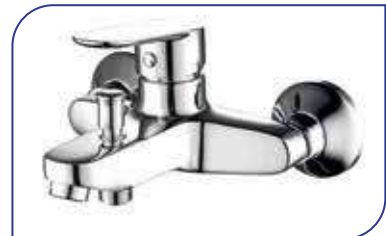

MIXER TAPES



MIXER TAPES



Made In Italy



Euroflow



3
LAYER

5
LAYER

26
BAR

UV
RESISTANT



CISTERN WC TANK



- High level Dudley Diplomat with chain pull.
- Internal parts comply with Regulator's Specification.
- Dudley Turbo 88 syphon for simple servicing.
- Approved by BMA Water Label Scheme.

Uses

- Ideal for use in light to medium duty domestic and commercial applications.

Features

- Traditional styling.
- Cistern body in high density polystyrene.
- Side inlet.
- Internal/external overflow warning.
- Internal parts comply with the Regulator's Specification.
- WRAS approved one piece Dudley syphon.
- Black and white low level models come with white lever as standard. Coloured models come with chrome plated lever. High level options supplied with chain pull.
- Suitable for high level, low level and close-coupled installations.

Water-saving

- 6/7/9 litre convertible full flush.
- Dudley Duoflush delivers water-saving reduced flush when lever is held down and full flush when lever is depressed and released.
- Approved by the Bathroom Manufacturer's Association Water Label Scheme.
- Supports Code for Sustainable Homes and BREEAM.

Options

- White, black or coloured cistern body.
- Dudley Hydroflo quiet inlet valve.
- Delay fill Hydroflo inlet valve that only allows cistern to start refilling once flushing is complete.
- Dudley Turbo 88 Duoflush syphon for servicing in under 5 minutes without disconnecting the water supply and dismantling the cistern.
- Bottom inlet.

EXPOSED CISTERNS

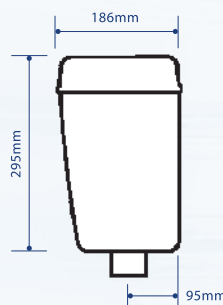
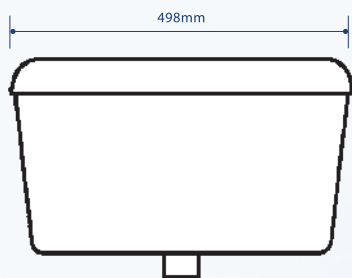

ACCESSORI POMPE
PUMPS ACCESSORIES

FLOAT SWITCH





BALL VALVES AND HP FITTINGS

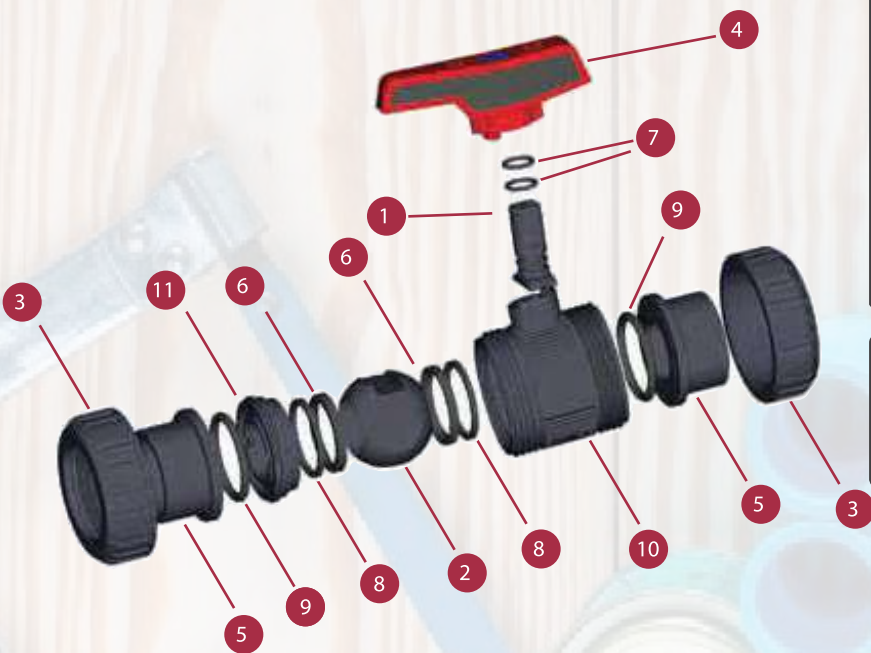

FLEXIBLE HOSE & SHATTAF





VICTORY
DIGITAL WALL & FLOOR TILES

PAVIT[®]
Inspired Mindscapes

WALL TILES - FLOOR TILES - VITRIFIED TILES - NANO TILES
DIGITAL TILES

GLOSSY, POLISHED, SILKY MATT, MATT

INOXPLATE | Stainless Steel Strainer

made in portugal



EUMEL
EMPRESA DE UTILIDADES METALICAS, LDA

GUARANTY

20
Years

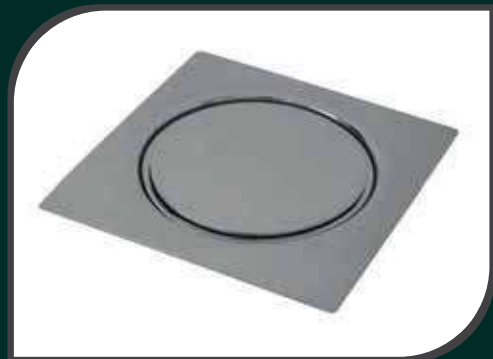



PPR MACHINE





SHATTAF & WC FITTINGS





SANITARY WARES (TOP ANCHOR)



Box Packing





SANITARYWARE





GALVANIZED PIPES & FITTINGS & RUBBER EXPANSION JOINT





MANHOLE COVER

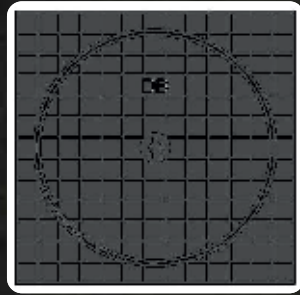
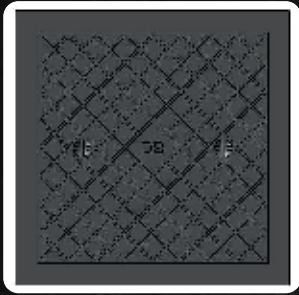



GULF-O-FLEX[®]
PRODUCT OF RUBBERWORLD

Z-FLEX

RUBBER INSULATION

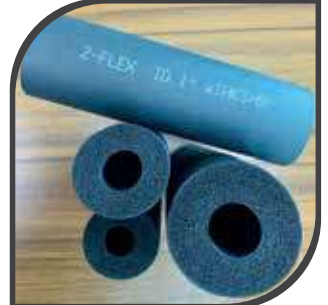

Z-FLEX COPPER PIPE IRON PIPE TUBE LENGTH 1.83 METERS (STANDARD)

Nominal Insulation Size ID	Nominal Size OD		Nominal Size IPS		Nominal 6 mm wall		Nominal 9 mm wall		Nominal 13 mm wall		Nominal 19 mm wall		Nominal 25 mm wall		Nominal 32 mm wall		
	mm	inch	mm	inch	mm	inch	Tube Size	Material Size	Tube Size	Material Size	Tube Size	Material Size	Tube Size	Material Size	Tube Size	Material Size	
6	1/8	6	1/8	-	100	325.4	106	307.94	90	164.7	30	31.8	55	64.03	16	14.9	
9	3/8	9	3/8	-	170	311.1	130	237.8	80	146.4	40	32.2	25	45.75	25	45.75	
13	1/2	13	1/2	6	1.4	230	274.3	133	210.4	65	112.9	40	32.2	25	45.75	20	36.6
16	5/8	16	5/8	10	3/8	220	219.6	90	164.7	60	109.8	35	34.3	25	45.75	20	36.6
19	3/4	19	3/4	-	-	100	181	76	128.0	45	32.3	30	34.3	20	36.6	15	27.4
22	7/8	22	7/8	13	1/2	80	146.4	70	128.1	40	32.2	30	34.3	20	36.6	15	27.4
25	1	25	1	-	-	70	128.1	55	100.4	40	32.2	25	45.75	20	36.6	15	27.4
28	1-1/8	-	1-1/8	19	3/4	60	109.8	55	100.4	36	33.8	25	45.75	18	32.94	15	27.4
32	1-1/4	32	1-1/4	-	-	50	100.4	40	73.2	30	34.3	20	36.6	15	27.4	15	27.4
35	1-3/8	35	1-3/8	25	1	30	81.3	36	85.40	30	34.3	20	36.6	15	27.4	12	27.96
38	1-1/2	38	1-1/2	-	-	-	-	-	-	34	41.32	17	31.71	12	27.96	12	27.96
42	1-5/8	42	1-5/8	32	1-1/4	-	-	30	34.3	25	45.75	17	31.71	12	27.96	10	18.3
48	1-7/8	48	1-7/8	38	1-1/2	-	-	25	45.75	20	36.6	15	27.96	10	18.3	10	18.3
51	2	51	2	-	-	-	-	20	36.6	15	27.4	9	16.47	9	16.47	9	16.47
54	2-1/8	54	2-1/8	-	-	-	-	25	63.5	20	36.6	15	27.4	11	16.47	9	18.47
60	2-3/8	60	2-3/8	51	2	-	-	20	36.6	18	32.4	12	27.96	9	16.47	6	10.98
67	2-5/8	67	2-5/8	-	-	-	-	18	32.94	15	27.4	10	18.3	8	14.64	6	10.98
73	2-7/8	73	2-7/8	-	-	-	-	18	32.94	15	27.4	10	18.3	8	10.98	4	7.32
76	3	76	3	-	-	-	-	16	32.94	12	27.96	10	18.3	8	10.98	4	7.32
79	3-1/8	79	3-1/8	-	-	-	-	15	27.4	12	27.96	10	18.3	6	10.98	4	7.32
86	3-1/2	86	3-1/2	75	3	-	-	11	27.4	10	18.3	8	14.64	6	10.98	4	7.32

Physical Properties			
1	Cell Structure	Closed	
2	60 - 75 Kg/m ³	Density (Kg/m ³)	BS 476 Part 6 & 7 ASTM D 4575- 91
3	Thermal Conductivity K Value at 40C mean Temperature	0.0328 w/m - E	ASTM C518 BS 874 1988
4	Temperature limit °C	-40 °C to +120 °C	
5	Thermal Stability % Shrinkage	2.54 (7 days at 95°C)	ASTM D 3575-91
6	Water Absorption	2.98	ASTM D 3575-91
7	Water vapor Permeability perm/Max	0.00 Perm - in	ASTM E 96-95 ASTM E 96-95
8	Resistance to Ozone	Excellent	ASTM D1149
9	Flammability	Self Extinguishing	ASTM D635-91
10	Fire Rating	Class 0, Class 1 25 / 50	BS 476 Part 6 & 7 ASTM E-84
11	Average time of Burning	Less than 4 Sec	ASTM D1149
12	Average extend of Burning	15min	
13	Flexibility	Excellent	ASTM D 1056-85
14	Resistance to Weather & Ultra Violet Rays	Very Good	ASTM G- 53-95
15	Resistance to Chemicals	Very Good	
16	Odour	Negligible	SAE J 1851
17	Mildew resistance	No Fungal Growth	ASTM G- 21-80
18	Copper Corrosion	Negligible	ASTM C 665-94

PAINT



PAINT



SEAT COVER AND CISTERN TANK

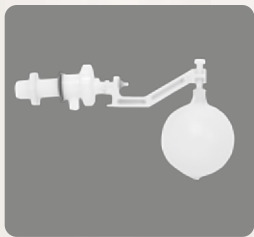

SEAT COVER

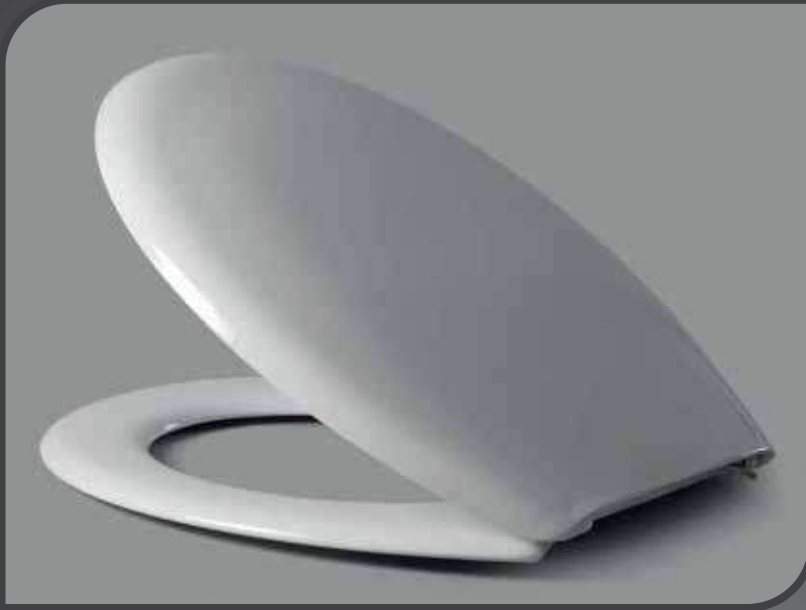

ELECTRICAL CABINET



WATER METER CABINET



ADHESIVES

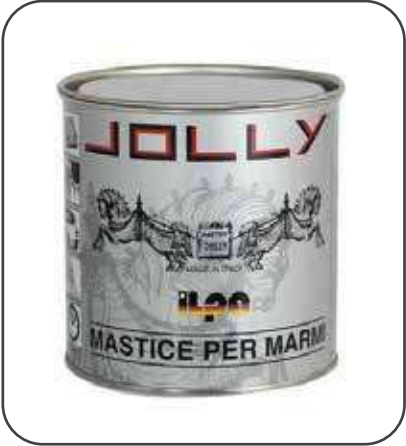



The Clear Choice
Water Filtration Systems





WATER FILTERS & CANDLES



SHOWER HEAD & SHOWER SET SERIES



H-9642-CBZ 5
Functions



HE-185042-CBB 5
Functions



HE-1842-CBB 5
Functions



H-022 8" 1
Functions



H-021 8" 1
Functions

SHOWER HEAD & SHOWER SET SERIES



H-5010 5
Functions



H-1099 1
Functions



H-5006 5
Functions



HC-1001 3
Functions



H-5097 5
Functions



H-642-B6 5
Functions



H-642-B11 3
Functions



H-1042-B11 5
Functions



H-9742-B11 5
Functions

WC FITTINGS



WC FITTINGS



SHATTAF AND SHOWER HOSE



BATHROOM ACCESSORIES



ANGLE VALVES & TAPS



ANGLE VALVES & TAPS



HESSE

BRASS ANGLE VALVES WITH FLANGE



HESSE

DOUBLE
BRASS ANGLE VALVES WITH FLANGE



HESSE

QUICK TURN
ANGLE VALVE WITH FLANGE SS



HESSE

ETTO



HESSE

QUICK TURN
DOUBLE CHROME PLATED



HESSE

QUICK TURN
DOUBLE CHROME PLATED



HESSE

SS COVER FLANGE

ETTO SOAP DISPENSER



Foam dispenser



Tissue dispenser

BATHTUB AND SHOWER TRAYS



□ EIL-215
□ 900 x 900 x 370mm



□ EIL-211
□ 800 x 800 x 330mm/900 x 900 x 330mm
1000 x 1000 x 330mm



□ EIL-206
□ 900 x 900 x 135mm



□ EIL-202
□ 700 x 700 x 135mm/800 x 800 x 135mm
900 x 900 x 135mm/1000 x 1000 x 135mm



□ EIL-208
□ 700 x 700 x 150mm/800 x 800 x 150mm
900 x 900 x 150mm



□ EIL-209
□ 800 x 800 x 150mm/780 x 780 x 150mm/790 x 790 x 150mm
800 x 800 x 90mm/800 x 800 x 150mm/900 x 900 x 150mm



□ EIL-204
□ 800 x 800 x 135mm/900 x 900 x 135mm



□ EIL-205R/L
□ 1000 x 800 x 135mm/1200 x 600 x 135mm
1200 x 900 x 135mm



□ EIL-219
□ 700 x 700 x 150mm/800 x 800 x 150mm
900 x 900 x 150mm



□ EIL-202
□ 700 x 700 x 135mm/800 x 800 x 135mm
900 x 900 x 135mm



□ EIL-220
□ 800 X 800 X 42mm/900 X 900 X 42mm/1000 X 1000 X 42mm



□ EIL-228
□ 800 x 800 x 135mm/900 x 700 x 135mm/1000 x 800 x 135mm
1500 x 800 x 135mm/1200 x 900 x 135mm



TOILET SEAT COVER

		<p>Item No.: HNC-003 (Normal Close) Material: PP Size: 430 x 360mm Inner ring: 277 x 234mm Adjustable length: 420-440mm</p>

		<p>Item No.: HSC-070 (Soft Close and quick release) Material: PP Size: 470 x 365mm Inner ring: 298 x 222mm Adjustable length: 460-480mm</p>

		<p>Item No.: HSC-026 (Soft/Normal Close) Material: PP Size: 420 x 335mm Inner ring: 270 x 205mm Adjustable length: 415-430mm</p>

		<p>Item No.: HNC-009 (Normal Close) Material: PP Size: 440 x 380mm Inner ring: 390 x 240mm Adjustable length: 430-450mm</p>



Auto Pressure Control horizontal



Auto Pressure Control Vertical



Float Switch



PRESSURE GAUGE

Stainless steel body - Brass threaded



TEFLON TAPE



HESSE



TEPNOX

GI THREADED ROD, CLAMPS & CP FITTINGS



CP FITTINGS



CP NIPPLES



THREAD RODS



GI FITTINGS



HOSE CLIP



GI CLAMPS



GI FLEXIBLE CONNECTOR

HESSE BRASS VALVES AND FITTINGS



HESSE BRASS VALVES



GATE VALVE BALL VALVE TANK CONNECTOR BIB TAP



BIB TAP HOSPITAL CLAMPS FLOAT VALVES

KITCHEN SINK



ELECTRICAL & HARDWARES & MACHINES

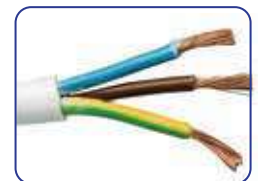



AQUAZONE

THE PROFESSIONALS' CHOICE

BATH FITTINGS



BATH FITTINGS



MIX PRODUCTS



CERTIFICATES



Pegler Yorkshire

Distributor Certificate



Pegler Yorkshire Group Limited are proud to appoint **Rodha Khalid Co.- Qatar** as an officially approved distributor of **Yorkshire Fittings Pegler Valves**

Pegler Yorkshire Group Limited is Registered in England No. 00491487 Registered Office High Park Road, Swarney, Leeds, West Yorkshire, LS10 1RE



YORKSHIRE COPPER TUBE

Ask for it by name

Distributor Certificate

Yorkshire Copper Tube hereby confirms that

RODHA KHALID CO.

are an officially appointed distributor for the sale of Yorkshire brand copper water tubes throughout the Gulf State of Qatar



Rodha Khalid

On behalf of Yorkshire Copper tube



Kitemarked Copper Tube



A Mueller Industries Company



Made in BRITAIN



Wednesbury COPPER TUBE

Distributor Certificate

Wednesbury Tube hereby confirm that

Rodha Khalid

are an officially appointed distributor for the sale of

Wednesbury Streamline

brand copper water tubes throughout Qatar



P.RO

Paul R. Dougherty
Export Sales Manager
Wednesbury Tube

MUELLER EUROPE LIMITED
DAFFODIL STREET, BILSTON, WEST MIDLANDS, WV14 3EQ
TEL: 01922 498100 FAX: 01922 405240
Registered in England No. 2116289 V.A.T. Registered No. 981 204 882



B METERS
Contatori per Acqua - Water Meters





Distribution Authorization

We, B METERS s.r.l. a Company existing under the Italian laws having its registered office in Via Frivik, 3-33050 GOMARS (UD) Italy, are a reputable and internationally renowned manufacturer of water meters.

Do hereby state that the Company RODHA KHALID Co., having its office at Al Mansoura Street-Najma, Cocha - Qatar is appointed as:

Authorized Distributor in the territory of QATAR of our complete range of water meters and accessories.

B METERS s.r.l.
Stefano Zampari

B-METERS S.R.L.
Via Frivik, 3
33050 GOMARS (UD)
C.F. e P.IVA 01790340300

B METERS s.r.l.
Via Frivik, 3
33050 GOMARS (UD)
ITALY

Cont. Fax: e P. IVA n° 01720040307 Tel: +39 0432 931455 - 921456
Via Frivik, 3
33050 GOMARS (UD) Call-Cen: e 800 005 201 e Fax: +39 0432 962081
Reg. Imp. e UD n° Imp. 017903403007 www.b-meters.com info@b-meters.com

CERTIFICATES



APPROVED STOCKIST
2017

This Certificate certifies that

RODHA KHALID CO
is an approved Conex | Bänninger Stockist

[Signature]

Pietro Cardente
International Sales Director

Conex Universal Limited
United Kingdom
www.conexbanninger.com



**SOLE DISTRIBUTOR
CERTIFICATE**

We hereby certify that
Rodha Khalid Co.
is one of our biggest authorized dealers of



PP-R Pipes and Fittings

We thank **Rodha Khalid Co.** for being a loyal customer
and an outstanding business partner



[Signature]
Sales Director





Issued: 28.11.2008

AUTHORISATION LETTER

We hereby declare that **Mrs. RODHA KHALID CO.** is one of the authorized distributors of **DIZAYN GROUP** in Qatar responsible for distributing **DIZAYN GROUP's** Super Seacore products (PP-R, HDPE Pipe and Waste Water Silnt pipes and fittings) in the territory of Qatar to their sub-district.

[Signature]

Mrs. Rodha Khalid
Gen. MGR/RODHA
Export Sales Director



**Design/Trade/Mark or
Registered as To A.S.**
Rodha Khalid Export Marketing
PO Box 17611 Doha, Qatar
Doha, Qatar
Tel: +974 973 988 07 08
Fax: +974 973 988 07 09
info@rodhakhalid.com
www.rodhakhalid.com



CERTIFICATE

This is to certify that the
Quality Management System of

**RODHA KHALID PLUMBING
AND ELECTRICAL MATERIALS CO WLL**
P.O BOX:5767, DOHA, QATAR

has been found to comply with
ISO 9001:2015

This certificate is applicable to the following scope:

TRADING OF BUILDING MATERIALS, SANITARY WARES,
CERAMIC, TILES, ELECTRICAL APPLIANCES, LIGHTS, PAINTS,
ADHESIVES, PLUMBING MATERIALS, HARDWARES, WATER
PUMPS, WATER HEATERS, WATER FILTERS, BATHROOM
ACCESSORIES, REFRIGERATION MATERIALS.

Certificate No.: BQSC202009023

Date of Initial Registration	14-09-2020
Surveillance Audit on or before	14-08-2021
Certificate Expiry	14-09-2021
Recertification Due	13-09-2023

[Signature]

Authorized Signatory
BQC Assessment Private Limited

Website: www.bqcnet.com, E-mail: info@bqcnet.com
Accredited by International Accreditation Service
The validity of this certificate can be verified at www.bqcnet.com or through info@bqcnet.com. This certificate is the property of BQC Assessment Pvt. Ltd. and must be returned on request. Accreditation details are available with IAS (International Accreditation Service) Inc. USA, at www.iasinc.org







RODHA KHALID COMPANY

"Conquering Excellence"...



 www.rodhakhalid.com

 +974 44310454

 +974 44435102

 P.O box : 5767

 sales@rodhakhalid.com